

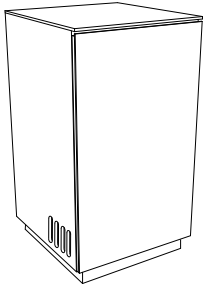

### Component List

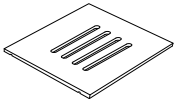

**A - Cabinet Assembly**  
x 1



**B - Adjustable Shelf** x 4

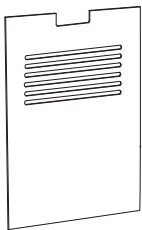

**C - Removable Back Panel**  
x 1

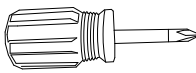

**D - Phillips Screwdriver**  
x 1

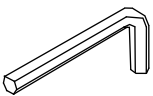

**E - Allen Wrench** x 1

Your Mirage Home Theater Furniture is engineered for easy assembly. Carefully follow this procedure to prevent any damage.

### Placement and Maintenance

Your Mirage Home Theater Furniture is designed for indoor use on level floors. Clean glass with glass cleaner; steel parts and wood veneer with a moist cloth.

### Step 1

#### Unpack and Identify

Unpack and identify the components at left. Note that some components are shipped inside the cabinet. The assembly workspace should be a non-marring surface such as carpet. For missing hardware pieces, please contact BDI Customer Service at customerservice@bdiusa.com. For all other concerns, please contact your BDI Retailer.

### Step 2

#### Shelves Installation

**Adjustable Shelf Pins** may be repositioned, allowing you to raise or lower the adjustable shelf to the desired level.

Install **Adjustable Shelf (B)** inside the left and right cabinet area. \*Note: To place the adjustable shelf inside the cabinet, the shelf may be tilted sideways to clear the door opening.

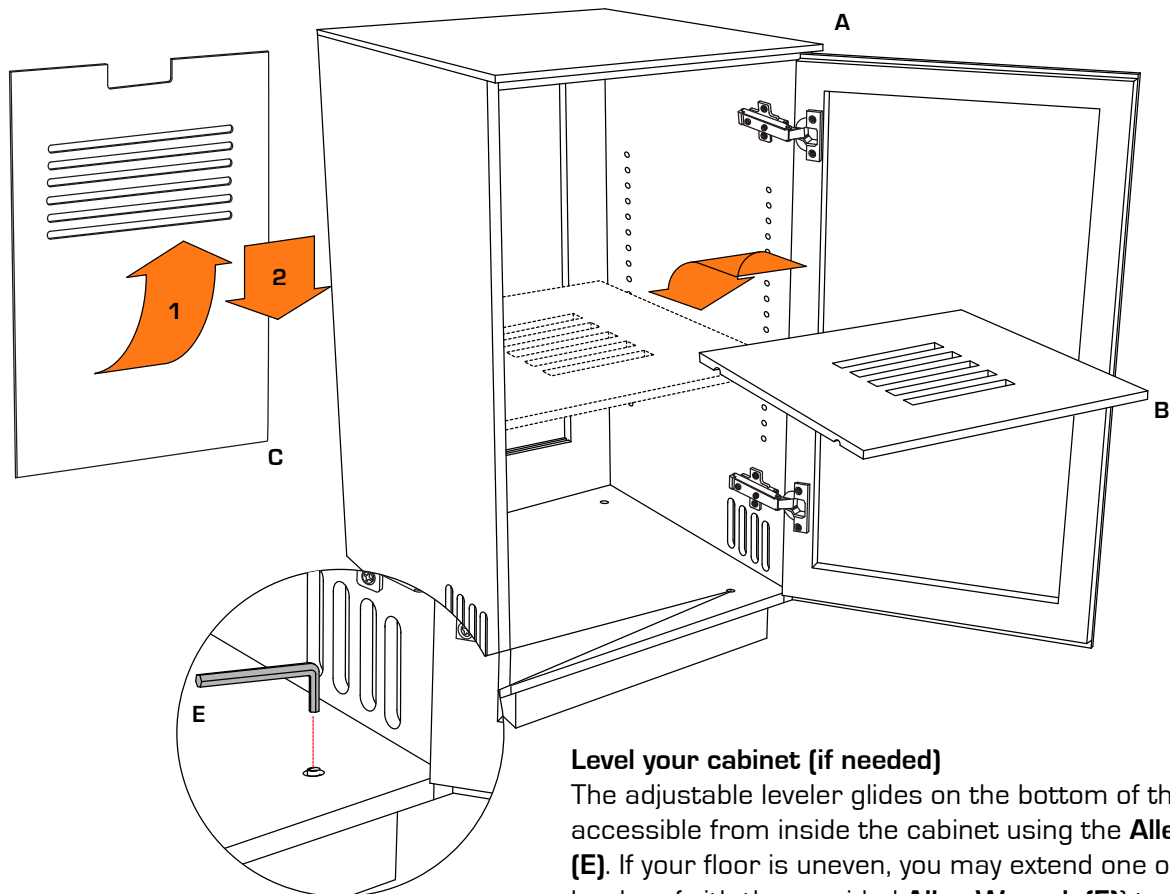

### Level your cabinet (if needed)

The adjustable leveler glides on the bottom of the cabinet are accessible from inside the cabinet using the **Allen Wrench (E)**. If your floor is uneven, you may extend one or more of the levelers (with the provided **Allen Wrench (E)**) to attain a level, stable cabinet placement.

### Step 3

#### Adjust Door Hinges (if needed)

If the cabinet's door appears out of alignment, this can be corrected with minor adjustment to the European hinges on each door.

Because these hinges are infinitely adjustable, adjusting one hinge element can sometimes cause the need for adjustments to other elements. But with a few adjustments, you can modify the orientation of the cabinet door to make sure that it hangs evenly.

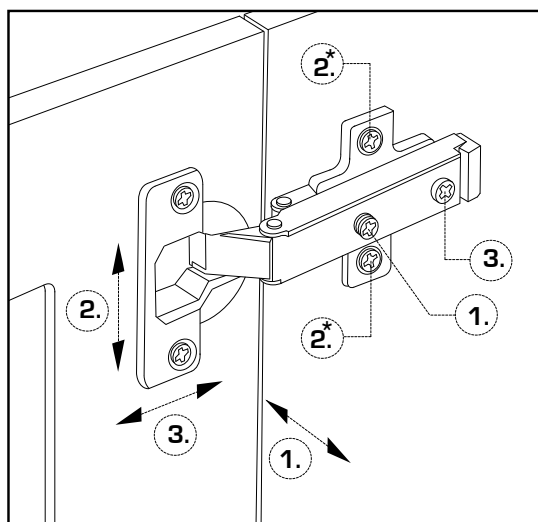

Use a Phillips screwdriver to adjust Mirage's door hinges:

- By adjusting **Screw 1**, the door will move LEFT or RIGHT within the frame. Make minor adjustments at both top and bottom hinges for best results.
- By adjusting **Screw(s) 2**, the door will move UP or DOWN within the frame (the top and bottom hinges must be adjusted the same degree).

**NOTE:** Loosen **Screws 2** one complete turn, raise or lower door, then hold in position while tightening **Screws 2** (on both hinges).

- By adjusting **Screw 3** the entire door will move IN or OUT, opening or closing the gap between the door frame and cabinet. (This screw rarely needs adjustment.)

### Step 4

#### Reverse Door-Swing (if desired)

Mirage Tower features a reversible door assembly so that you can open either from the left or the right.

To reverse the door's orientation,

1. Remove the Door by actuating both of its quick-release hinges; carefully place the detached Door aside.
2. Using a Philips head screwdriver, remove both Hinge Plates from the interior wall of the cabinet by loosening the screws holding it in place.
3. Install both Hinge Plates to the opposite interior wall at the pre-determined locations.
4. Re-install the Door by connecting each Door Hinge to the relocated Hinge Plates.

The Mirage 8222 features an opening at the top area of the back surface that can accommodate a small fan for the purpose of active cooling. BDI does not supply fans, but you may find several on the market which are compatible with the size and shape of this opening.